

SPC-3520

Ultra-compact Embedded System with Intel® Core™ i7/ i5/ i3 Processor (Skylake-U), -40°C to 85°C, 4 GigE LAN, 1 SSD, 1 SIM, 4 USB 3.0, 5 COM, Isolated DIO, Fanless, Rugged, Extended Temperature



Features

- Intel® Core™ i7/ i5/ i3 U-series SoC (Skylake-U)
- Fanless design, -40°C to 85°C Operating Temperature
- 9V to 36V DC Power Input, 16 Isolated DIO
- DDR4 2133MHz memory, up to 16GB
- Onboard DVI-D and DisplayPort display interfaces support up to 4K resolution
- Up to 5 Independent GigE LAN, iAMT 11.0 supported
- SIM socket for 3G/ 4G/ LTE/ WiFi/ GPRS/ UMTS
- 4 USB 3.0, 5 COM RS-232/ 422/ 485
- Optional supports full function SUMIT A, B expansions
- One-stop SUMIT Expansion Design and Manufacturing Services



Specifications

System	
Processor	Intel® Core™ i7-6600U/ i5-6300U/ Celeron® 3955U (Skylake-U)
Chipset	Intel® SoC (Skylake)
BIOS	AMI
SIO	IT8786E
Memory	1 DDR4 2133MHz SO-DIMM, up to 16GB
I/O Interface	
Serial	5 COM RS-232/ 422/ 485
USB 3.0	4 USB 3.0 (External)
USB 2.0	SPC-3520-600U, SPC-3520-300U : 4 USB 2.0 (Internal) SPC-3520-955U : 2 USB 2.0 (Internal)
Isolated DIO	16 Isolated DIO : 8 DI, 8 DO
LED	Power, HDD
SIM Card	1 SIM Card Socket (Internal)
Expansion	
Mini PCIe	2 Mini PCIe Socket : ▪ 1 Full-size for PCIe/ USB/ Internal SIM Card ▪ 1 Full-size for PCIe/ USB/ mSATA
SUMIT A, B	2 SUMIT Slot (Optional)
Graphics	
Graphics Processor	Intel® HD Graphics 520
Interface	▪ DVI-D : Up to 1920 x 1200 @ 60Hz ▪ DisplayPort : Up to 4096 x 2304 @ 60Hz
Storage	
SATA	2 SATA III (6Gbps)
mSATA	1 SATA III (Mini PCIe Type, 6Gbps)
Storage Device	1 2.5" SSD/ HDD Bracket (Internal)
Audio	
Audio Codec	Realtek ALC892, 5.1 Channel HD Audio
Audio Interface	1 Mic-in, 1 Line-out
Ethernet	
LAN 1	Intel® I219LM GigE LAN supports iAMT 11.0
LAN 2	Intel® I210 GigE LAN
LAN 3	Intel® I210 GigE LAN
LAN 4	Intel® I210 GigE LAN

Power	
Power Input	9V to 36V, DC-in
Power Interface	3-pin Terminal Block : V+, V-, Frame Ground
Remote Switch	2-pin Terminal Block : On, Off
Others	
Watchdog Timer	Reset : 1 to 255 sec./min. per step
Smart Management	Wake on LAN, PXE supported
HW Monitor	Monitoring temperature, voltages. Auto throttling control when CPU overheats.
Software Support	
OS	Windows 10, Windows 8.1, Windows 7, Linux
Mechanical	
Dimensions (W x L x H)	150mm x 106mm x 86mm (5.92" x 4.18" x 3.39")
Weight	1.8 kg (4.0 lb)
Mounting	▪ Wallmount by mounting bracket ▪ DIN Rail Mount (Optional) ▪ 2U Rackmount (Optional)
Environment	
Operating Temperature	-40°C to 85°C (-40°F to 185°F)
Storage Temperature	-40°C to 85°C (-40°F to 185°F)
Humidity	5% to 95% Humidity, non-condensing
Relative Humidity	95% @ 70°C
Shock	▪ IEC 60068-2-27 ▪ SSD : 50G @ wallmount, Half-sine, 11ms
Vibration	▪ IEC 60068-2-64 ▪ SSD : 5Grms, 5Hz to 500Hz, 3 Axis
Certification	CE, FCC, EN50155, EN50121-3-2

Dimensions

Unit : mm/ inch

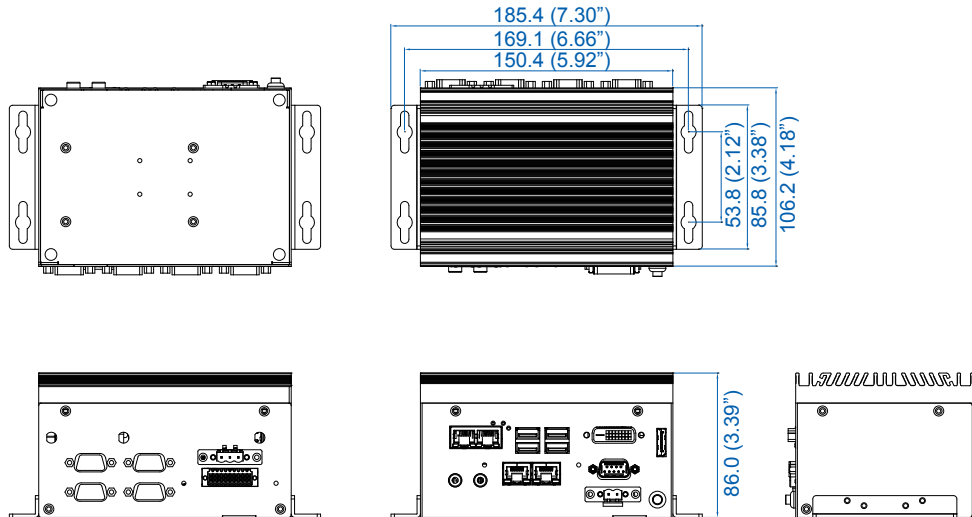

Front I/O

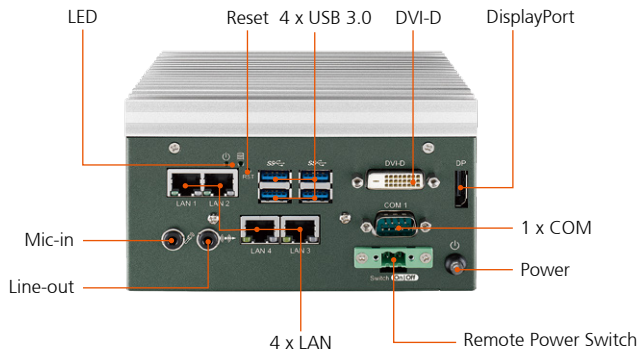

Rear I/O

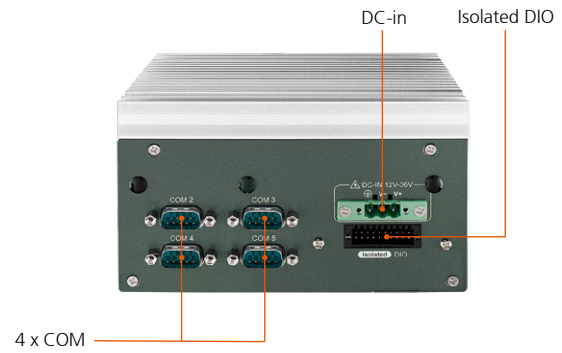

Order Information

SPC-3520-600U	SPC-3500, Intel® Core™ i7-6600U, 4 GigE LAN, 1 SSD, 4 USB 3.0, 5 COM, 1 SIM, Isolated DIO
SPC-3520-300U	SPC-3500, Intel® Core™ i5-6300U, 4 GigE LAN, 1 SSD, 4 USB 3.0, 5 COM, 1 SIM, Isolated DIO
SPC-3520-955U	SPC-3500, Intel® Celeron® 3955U, 4 GigE LAN, 1 SSD, 4 USB 3.0, 5 COM, 1 SIM, Isolated DIO
DDR4 16G	Certified DDR4 16GB 2133MHz RAM
DDR4 8G	Certified DDR4 8GB 2133MHz RAM
DDR4 4G	Certified DDR4 4GB 2133MHz RAM
PWA-160W-WT	160W, 24V, 85V AC to 264V AC Power Adapter with 3-pin Terminal Block, Wide Temperature -30°C to +70°C
PWA-120W	120W, 24V, 90V AC to 264V AC Power Adapter with 3-pin Terminal Block
TMK2-20P-100	Terminal Block 20-pin to Terminal Block 20-pin Cable, 100cm
TMK2-20P-500	Terminal Block 20-pin to Terminal Block 20-pin Cable, 500cm
TMB-TMBK-20P	Terminal Board with One 20-pin Terminal Block Connector and DIN-Rail Mounting
VESA Mount	VESA Mounting Kit
DIN-RAIL	DIN Rail Kit
Rack Mount	2U Rackmount Kit
3G Module	Mini PCIe 3G/GPS Module with Antenna
4G Module	Mini PCIe 4G/GPS Module with Antenna
WiFi & Bluetooth Module	Intel® MiniPCIe WiFi & Bluetooth Module with Antenna